

Serial Server

SSE232-LE

User's Manual

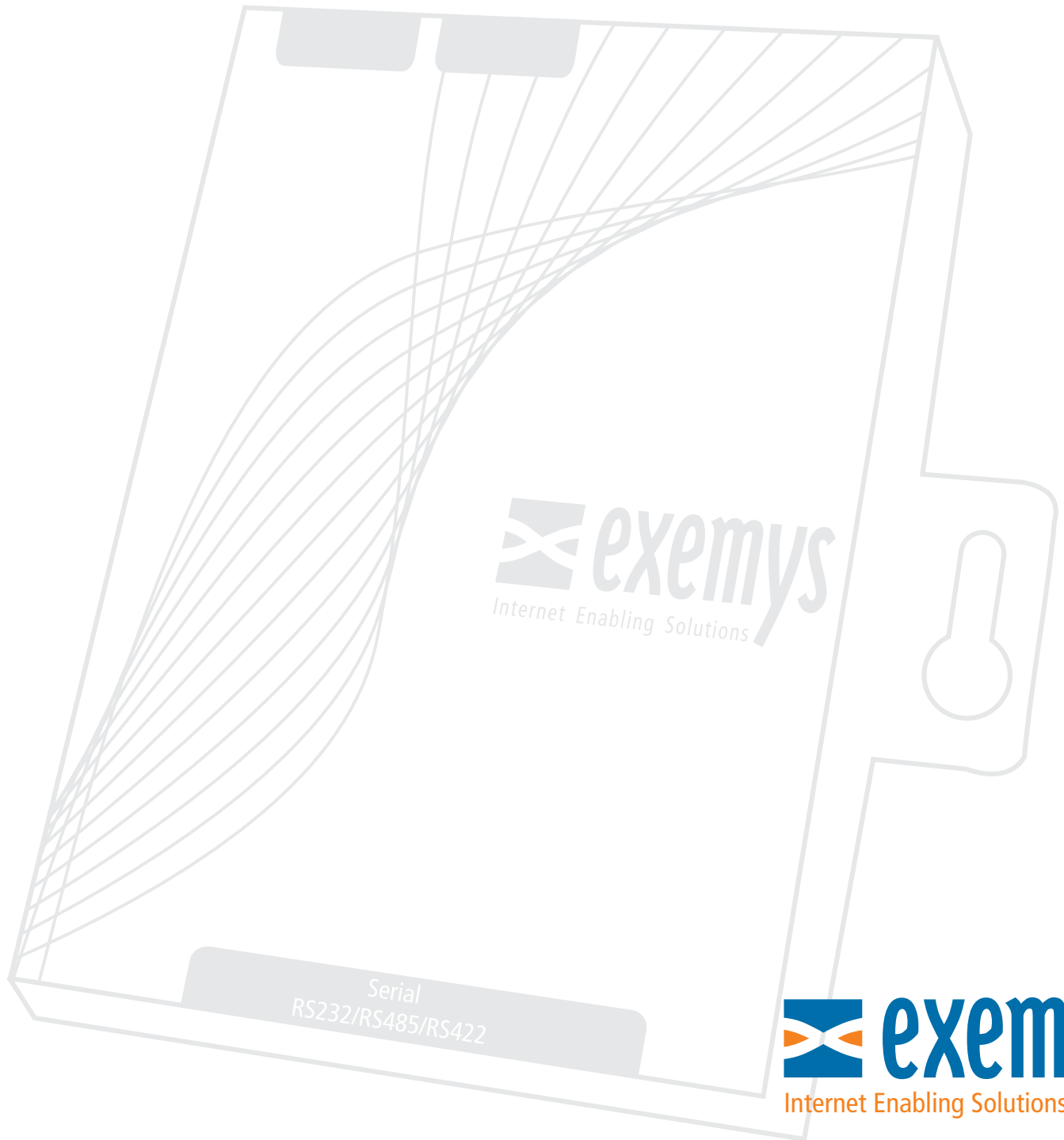

ISO 9001:2000



Exemys Products are in constant evolution to satisfy our customer needs.
For that reason, the specifications and capabilities are subject to change without prior notice.
Updated information can be found at www.exemys.com

Copyright © Exemys, 2006 All Rights Reserved.
Rev. 1.0.3

Table of Contents

INTRODUCTION	5
1.1 The Manual	5
1.1.1 Purpose of the Manual	5
1.1.2 Conventions, terms and acronyms	5
1.2 Product Description	6
INSTALLATION	7
2.1 Power Connection	7
2.2 Serial Connection	7
2.2.1 RS-232 Connection	7
2.2.2 RS-485 and RS-422 Connection	8
2.3 Ethernet Connection	9
2.3.1 Connection through a Hub or Switch	9
CONFIGURATION AND OPERATION	10
3.1 Getting Started	10
3.1.1 IP Address Configuration	10
3.1.2 Access to configuration Web page.	11
3.1.3 TCP Configuration Command Console.	12
3.1.4 Serial Configuration Command Console	12
3.1.5 Configuration of Network Basic Parameters through the console	13
3.2 Operation	13
3.2.1 Introduction	13
3.2.2 SSE232-LE General Configuration	15
3.2.3 Configuration of serial ports	17
3.2.4 Inactivity timeout and Automatic Reset	19
3.2.5 Server Mode Channel Configuration	20
3.2.6 Client Mode Channel Configuration	21
3.2.7 Multidrop Mode	22
3.2.8 Supervision and Control Port.	23
3.3 UDP Transport Protocol	24
3.3.1 Client Channel with UDP Protocol	25
3.3.2 Server Channel with UDP Protocol	25
3.3.3 Connection Between Two UDP Clients.	26
A. APPENDIX	27
A.1. Device Locator Application	27
A.2. Indicator Leds Codes	29

A.3.	Default Configuration	30
A.4.	Connectors Pinout	30
A.5.	Technical Specifications	31

Tables

Table 1 - Acronyms	5
Table 2 - Conventions	5
Table 3 - PASSWORD command	15
Table 4 - WEBCFG command	16
Table 5 - FACTRESET command	17
Table 6 - RESET command	17
Table 7 - Configuration of serial ports	19
Table 8 - ARESET command	20
Table 9 - Server Mode Channel Configuration	21
Table 10 - Client Mode Channel Configuration	22
Table 11 - STA and RST commands	24
Table 12 - PROTOCOL command	24
Table 13 - Default Configuration	30

Figures

Figure 1 - Detail of the Codification of the models	6
Figure 2 - Connectors	7
Figure 3 - COM A to PC cable	8
Figure 4 - RS485 & RS422 Networks	8
Figure 5 - Scheme of connection without crossover network cable	9
Figure 6 - Socket-Port Scheme	14
Figure 7 - Multidrop Mode: up to 8 clients	23
Figure 8 - An SSE232-LE Client Broadcasts to all clients with IPSERV = Fixed IP	25
Figure 9 - Two SSE232-LE UDP, one client and one server	26
Figure 10 - Connection between two UDP clients	26
Figure 11 - Exemys Device Locator	27
Figure 12 - Indicator Leds Codes	29
Figure 14 - Connectors Pinout	30

Chapter 1

Introduction

1.1 The Manual

1.1.1 Purpose of the Manual

The purpose of this manual is to provide instructions for the fast and simple installation and operation of SSE232-LE over your Ethernet network.

The manual starts with the product description and then provides instructions for proper installation of its hardware. Later on, it includes detailed information on SSE232-LE configuration and operation.

1.1.2 Conventions, terms and acronyms

The acronyms used in this manual are listed in the following chart.

Table 1 - Acronyms

Acronym	Description
ARP	Address Resolution Protocol
bps	Bits per second
HTTP	HyperText Transfer Protocol
IP	Internet Protocol
LAN	Local Area Network
PC	Personal Computer
UDP	User Datagram Protocol
TCP	Transmission Control Protocol
DHCP	Dynamic Host Configuration Protocol
GND	Ground (Reference)

The conventions listed below are used in this manual.

Table 2 - Conventions

Convention	Description
A B C	A set of possible values for command parameters. You can type A, B or C.
n..m	A range of possible values. You can type any value in the range including n and m.
(text)	Any text, such as a server address.
aaa.bbb.ccc.ddd	An IP Address.

1.2 Product Description

SSE232-LE is a RS-232/485/422 converter to the Ethernet and vice versa. It allows access, through the Ethernet, to equipment like alarm panels, data acquiritors, PLCs or any other device with a serial interface.

SSE232-LE is the interface between the equipment with serial communication and the Ethernet network, acting as a transparent converter . Figure 1 shows the codification used by each model in detail.

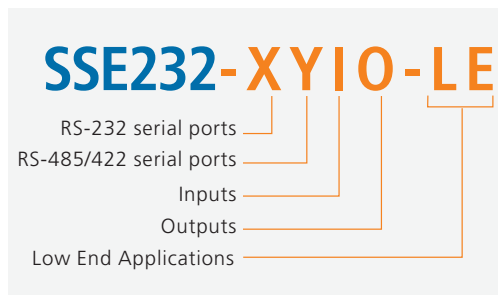

Figure 1 - Detail of the Codification of the models

Chapter 2

Installation

2.1 Power Connection

SSE232-LE powering has no polarity and accepts an input voltage range of 9 to 30 VDC and 9 to 26 VAC.

2.2 Serial Connection

COM A is found in the DB25 DTE female connector, as shown in figure 3.
COM A can be configured as RS-232, RS-485 or RS-422.

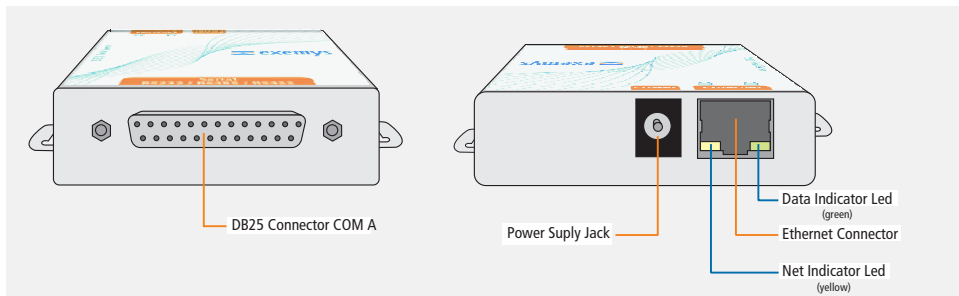

Figure 2 - Connectors

2.2.1 RS-232 Connection

If you need to connect COM A to a computer (or any DTE device) use the following cable.

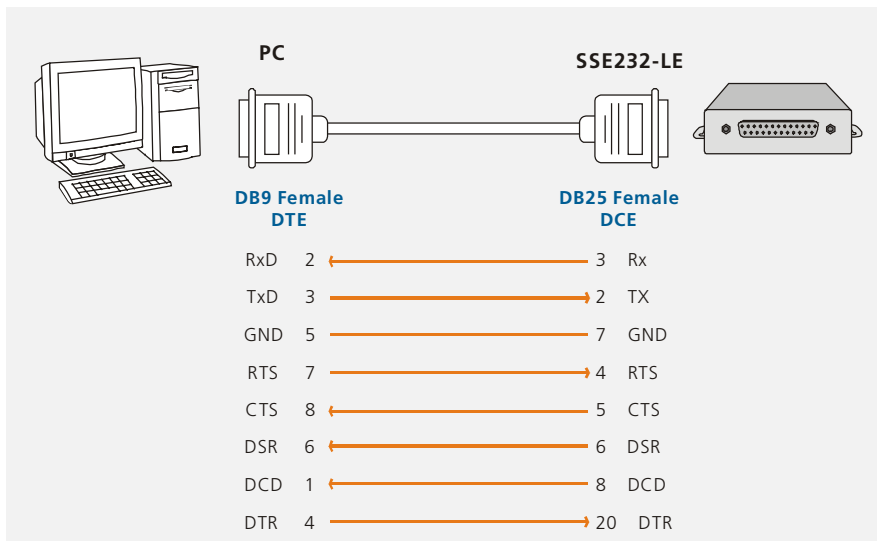

Figure 3 - COM A to PC cable

2.2.2 RS-485 and RS-422 Connection

Use terminals TRX+ and TRX- to connect SSE232-LE to a RS485 network. And use terminals TRX+, TRX-, RX+, RX- to connect SSE232-LE to a RS422 network.

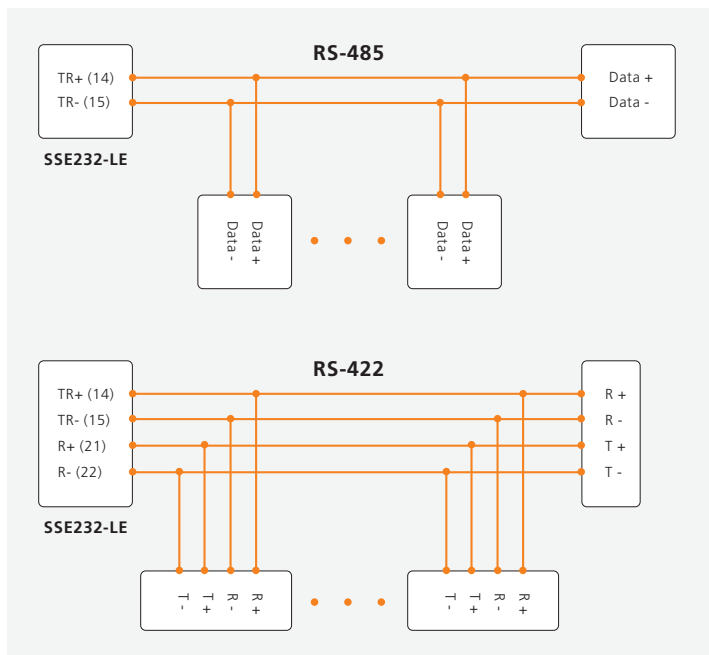

Figure 4 - RS485 & RS422 Networks

2.3 Ethernet Connection

RJ45 connector is used for the Ethernet connection. The Ethernet connection is essential for SSE232-LE to operate. It can be connected to a Hub or Switch with an standard network cable.

2.3.1 Connection through a Hub or Switch

A UTP network cable is used to connect SSE232-LE to the Ethernet through a Hub or Switch.

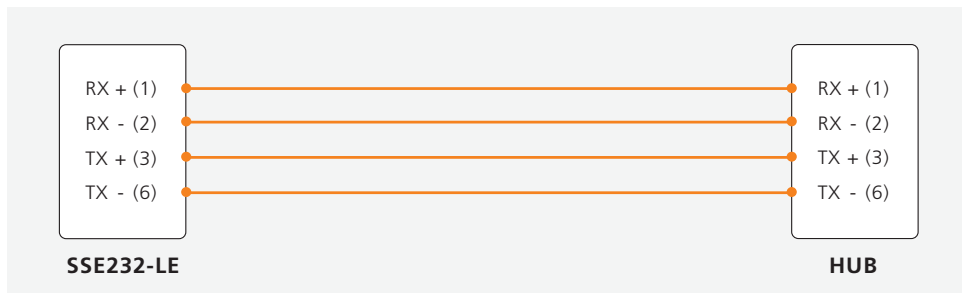

Figure 5 - Scheme of connection without crossover network cable

Chapter 3

Configuration and Operation

3.1 Getting Started

The first step consists in obtaining an IP address for SSE232-LE , by any of the following means:

- Using the Device Locator application program (most recommended method).
- Forcing an IP address entry to the ARP table.
- Locally, by accessing the command console provided by SSE232-LE , at the serial connection.

Once SSE232-LE has an IP address, the rest of the parameters can be configured:

- By accessing the configuration web page of the equipment (most recommended method).
- Using the TCP command console.
- Locally, by accessing the command console provided by SSE232-LE , at the serial connection.

All configuration parameters are permanently stored in the memory and will be maintained even in the event the equipment shuts down. Configuration parameters may be modified at any time using any of the methods mentioned above.

3.1.1 IP Address Configuration

SSE232-LE default configuration is IP 0.0.0.0, so when turned on, it will search for a DHCP server. SSE232-LE tries to negotiate an IP address with the DHCP server for a maximum period of 10 seconds. If the DHCP server fails to answer in that period, SSE232-LE will show an error code by means of its indicator LEDs (see annex) and will try to establish connection with the DHCP server 60 seconds later. This process will be repeated indefinitely until a DHCP server assigns an IP address to SSE232-LE or until the user assigns a static IP address. During the negotiation process, SSE232-LE 's yellow LED is steady on.

If you decide that SSE232-LE should have a static IP address (not assigned by a DHCP server) use the Device Locator Software (Chapter 4.1) or the serial console method (3.1.4)

There's a third method to assign an IP address to the SSE232-LE , the ARP method.

If SSE232-LE receives, within 7 seconds after being turned on, an ICMP packet through a ping, it will take the destination IP of this packet, provided it is different from that configured in SSE232-LE.

To this effect, an entry can be added to the ARP table of a PC in the network.

The Windows ARP table must have at least one IP address other than its own in order for the ARP command to work. Be sure the ARP table has at least one entry with the command:

```
arp -a
```

If the local machine is the only entry, send a ping to another device in the network. Then add the entry to the ARP table of the PC, entering the following command:

```
arp -s 192.168.0.105 00-90-C2-XX-XX-XX
```

In Unix, the command to add an entry to the ARP table is the following:

```
arp -s 192.168.0.105 00:90:C2:XX:XX:XX
```

Send a ping to the IP address you added to the ARP table on the previous step, by entering the following command:

```
ping 192.168.0.105 -t
```

The `-t` option will cause the ping to be continuously sent.

Turn SSE232-LE on. The equipment will only respond after a few seconds. Once SSE232-LE has responded to the ping, you will have access to the equipment over the network.

3.1.2 Access to configuration Web page.

Once SSE232-LE has a valid IP address you may access the web page to configure the rest of the parameters. You must use a web navigator that allows the use of Java Scripts.

1. If your web navigator is configured to search for a Proxy server, disable that option.
2. Type the SSE232-LE IP address in the "address" field of your navigator.



SSE232-LE will ask for the password to enter to the page. Type "admin" as user name and then the password to enter.

3. You will see the SSE232-LE configuration web page. On the left side, you will find the menu, and on the right side, you will find the configuration page.

3.1.3 TCP Configuration Command Console.

SSE232-LE supplies a command console to allow configuration by TCP in the `port 998`. The machine will only administer one connection in this port, thus preventing the device to be configured in simultaneous consoles.

To enter the console establish a telnet connection to port 998. In Windows, open a window of commands and type the following command:

```
telnet 192.168.0.105 998
```

When the connection is established, SSE232-LE will show a welcome message to the configuration command console.

```
SSE232-LE - Exemys (V2.0) :  
-----  
Password:
```

SSE232-LE will ask for a "Password":

You will then have three opportunities to enter your password. After that, the console will be blocked for 5 seconds before allowing you to re-enter your password.

3.1.4 Serial Configuration Command Console

Locally, you can access the serial port command console by connecting SSE232-LE to a RS-232 port of a PC. To such effect, you must have a serial terminal program (Windows HyperTerminal or the like).

The communications program must be set as follows: **9600 bps, Parity: None, Data bits: 8, Stop bits: 1, and flow control: none (9600,N,8,1)**.

You can enter the configuration mode through the serial port:

- Connect SSE232-LE to a PC and configure the terminal emulation program to 9600,N,8,1.
- Turn on SSE232-LE . During the first 7 seconds SSE232-LE will wait for the **CFG** command.
- Type **CFG** and press ENTER. The SSE232-LE will display a welcome message to the configuration command console.

```
SSE232-LE - Exemys (V2.0) :  
-----  
>_
```

3.1.5 Configuration of Network Basic Parameters through the console

Once you access the console, you can change the network configuration parameters with the following commands: **IP**, **NETMASK**, and **GATEWAY**. If you want to change the SSE232-LE IP address, Netmask and / or Gateway, you can enter the commands to modify these parameters. But then you must enter the **END** command so the changes take effect. When the **END** command is executed, SSE232-LE will detect that any of these three basic parameters has been changed and the system will be restarted. If the console is run from a Telnet session, the communication with the equipment will be interrupted. You must reopen the TCP session using the new IP address.

- To change the IP address, enter the following command:

```
>ip:192.168.0.110
Ok, IP Address      192.168.0.110
NOTICE, This parameter will be accepted upon execution of the END command.
At that moment, communication with the equipment will be interrupted.
If you are not sure, close communication without typing the END command.
>_
```

- To change the **netmask**, enter the following command:

```
>netmask:255.255.255.0
Ok, Netmask        255.255.255.0
NOTICE, This parameter will be accepted upon execution of the END command.
At that moment, communication with the equipment will be interrupted.
If you are not sure, close communication without typing the END command.
>_
```

- You can change the Gateway using the **gateway** command. Enter the following command:

```
>gateway:192.168.0.200
Ok, Gateway        192.168.0.200
NOTICE, This parameter will be accepted upon execution of the END command.
At that moment, communication with the equipment will be interrupted.
If you are not sure, close communication without typing the END command.
>_
```

- Enter the **END** command for SSE232-LE to accept the network parameter changes. You will lose communication with the equipment if the commands were entered from the TCP console.

3.2 Operation

3.2.1 Introduction

In SSE232-LE, each COM (A, B, C or D) corresponds to a TCP socket. Thus, once communication with any of these sockets is established, information will be transparently transferred from the corresponding COM to the socket and vice versa.

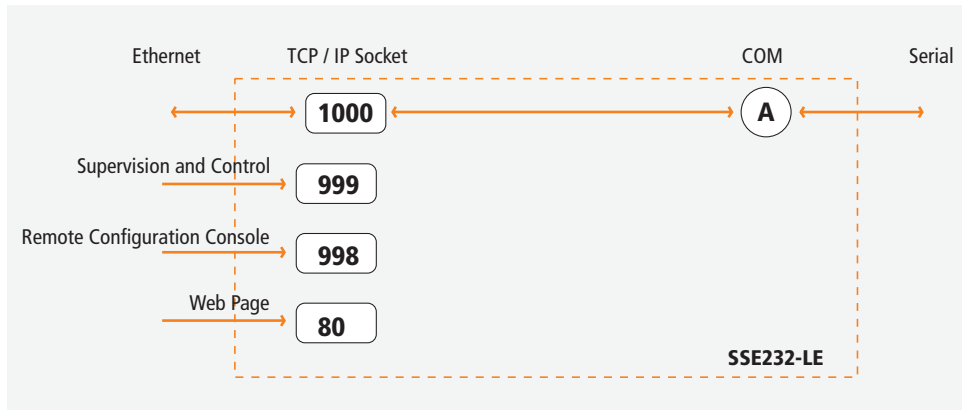

Figure 6 - Socket-Port Scheme

The communication sockets that are in correspondence with the serial ports are flexible and completely configurable. The SSE232-LE is configured by the manufacturer so that TCP ports 1000, 1001, 1002 and 1003 are correspondent to COM A, B, C y D respectively, but this may be changed in each COM's configuration.

As it can be observed in figure 14, SSE232-LE has also 3 fixed TCP ports: Supervision and Control (Port 999), Configuration Command Console (Port 998) and HTTP Server (Port 80).

Through the Supervision and Control Port (Port 999) you will be able to supervise the status of each channel and administer SSE232-LE inputs/outputs.

SSE232-LE configuration command console is available on Port 998.

Each of the COM–socket TCP channels can function either in Client Mode or in Server Mode.

3.2.1.1 Server Mode

If a COM–socket channel is configured to function in server mode in a port configured by the user, SSE232-LE will be on hold on that TCP port, waiting for a client to establish the connection (each client will have to connect to the IP address and port of the server). Once the connection is established, all the information received in the socket will be transmitted to the corresponding serial port and vice-versa.

3.2.1.2 Client Mode

When operating in client mode, each COM-socket channel will have the IP address and port of the server they have to connect to. Thus, that channel will try to establish communication with the server every 10 seconds and, once established, the data received in the socket will be transmitted by the corresponding serial port and vice versa.

3.2.1.3 DTR Client Mode

DTR client mode is similar to Client Mode but in this case the SSE232-LE will wait for the DTR signal to go on before trying to establish the connection. The SSE232-LE will finish the connection if the DTR signal goes off.

3.2.2 SSE232-LE General Configuration

In this chapter, we will focus on the general aspects of SSE232-LE configuration.

3.2.2.1 How to obtain help from the command console.

To obtain help regarding a specific command, you can type the command followed by an interrogation mark "?". The console will display a help message, the syntax and a descriptive text.

```
>port?
PORTx:...      Listen Port (1..65535)

>_
```

There also exist the **HELP**, **HELPP** y **HELPS** commands. The first two will display a complete list of all available commands with their syntax and a descriptive text. The **HELPS** command lists the commands for the Supervision and Control Port.

3.2.2.2 Configuration Password

Both the TCP configuration console and the web page are protected by a password. The device administrator may assign access key for these resources, thus supplying safe access to SSE232-LE configuration.

To change the password through the Web page:

- Select "Advanced" from the menu, you will see the advanced configuration page.
- Enter the Password in the "New Password" box, and type it again to confirm.
- Click on the "Change Password" button, so the SSE232-LE may take the changes.



The administrator may change the password for the command console (both through TCP or, locally, through the serial port) by using the **PASSWORD** command.

Table 3 - PASSWORD command

Command	Description
PASSWORD: (password)	Changes the password for remote configuration (TCP command console or configuration Web Page). The password must not have more than 10 characters.

3.2.2.3 Enabling and Disabling Web Configuration

The administrator may enable or disable SSE232-LE configuration through the Web page. Once disabled, the administrator will only be able to access the configuration remotely through the TCP command console or, locally, by the serial command console. In both cases, the administrator will be able to re-enable Web Configuration.

To enable or disable SSE232-LE Web Configuration page through the web page:

- Select "Network" from the menu, you will see the Network configuration page.
- Select the Web Configuration Enabling from the combo box.
- Click on the "Send" button, so the SSE232-LE may take the changes.

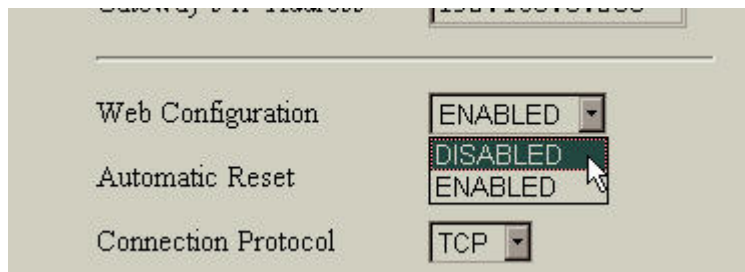

From the command console (via TCP or serial), you may enable or disable the option of configuration through the web page by executing the **WEBCFG** command.

Table 4 - WEBCFG command

Command	Description
WEBCFG: (E D)	Enables or disables configuration through web page. E = Enables D = Disables

3.2.2.4 How to reset to manufacturer's configuration

At any time, SSE232-LE administrator may reset to the original manufacturer's configuration. This option may be executed both through the Web page and through the command console.

To reset the original manufacturer's configuration from the SSE232-LE Web page:

- Select "Advanced" from the menu, you will see the advanced configuration page.
- Click on the "Set SSE232-LE to Factory Defaults" button. A message will appear asking you to confirm the action.
- Select "Yes" if you want to reset SSE232-LE to Factory Default Configuration.

From the command control you may execute the **FACTRESET** command to reset the original configuration. This command must be entered twice for the SSE232-LE to reset to its predetermined configuration.

Table 5 - FACTRESET command

Command	Description
FACTRESET	Resets the original manufacturer's configuration. This command must be entered twice for the SSE232-LE to reset to the manufacturer's configuration.

3.2.2.5 SSE232-LE Reset

If necessary, SSE232-LE may be reset. If SSE232-LE is reset, all connections are closed and SSE232-LE returns to its initial status.

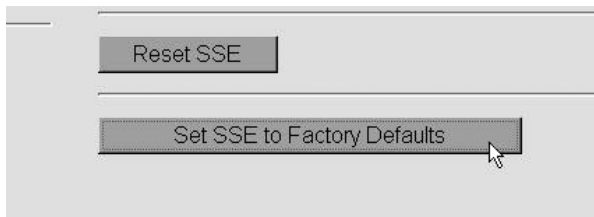

To reset SSE232-LE through the Web page:

- Select "Advanced" from the menu, you will see the advanced configuration page.
- Click on the "Reset SSE232-LE " button. A message will appear asking you to confirm the action.
- Select "Yes" if you want to reset SSE232-LE .

From the command console, you may reset SSE232-LE by executing the **RESET** command.

Table 6 - RESET command

Command	Description
RESET	Resets the SSE232-LE This command must be entered twice for SSE232-LE to reset.

3.2.3 Configuration of serial ports

SSE232-LE 's serial port may be configured according to your needs. The configuration parameters of each COM are:

- **Baud Rate:** Serial Port Rate of transference by bits per second. Possible values are: 300, 600, 1200, 2400, 4800, 9600, 14400, 19200, 28800, 33600, 38400 , 57600 y 115200.
- **Parity:** Type of parity. Possible values are: NONE (without parity), EVEN (Even Parity) and ODD (Odd parity).
- **Bits of data:** Bits of data of the COM. Possible values are: 7 y 8.
- **Flow Control:** For COM type RS-232 in models 1083, 1C43 and 2043, flow control, if wanted, may be configured by hardware (RTS/CTS). Possible values are: With flow control and without flow control .

- **Type of Serial Port (only SSE232-1C43-LE):** In the SSE232-1C43-LE model, you can select what type of serial port will be COM A, which is the only one available in this model. You may select RS-232 with or without flow control by hardware, RS-485 or RS-422. In each case, the COM will always be A, the one thing that changes is the way to establish the connection and the COM location in the SSE232-LE connectors (see "Installation").
- **Window of time:** Once the first data is received in the COM, SSE232-LE will wait for this specified period of time before sending a packet over the Ethernet network through the corresponding socket. Thus, the band width of the Ethernet is improved, as it allows to gather the bytes received by the serial port in an only packet. On the other hand, it incorporates a delay in the transmission of information, which should be carefully treated according to the serial protocol in use. If such protocol does not allow any delay, we recommended to configure the window of time in 0. Possible values for the window of time range from 0ms to 2000ms.
- **End Character:** Indicates the last character of a pattern to form the TCP package. If it is used together with a value of window of time different from 0ms, the arrival of the end character or the lapse of the time of the window, whichever happens first, will have priority.

To configure these parameters through the SSE232-LE Web Page:

- Select the "COM A" in the menu
- Enter the values as necessary. For the End Character parameter, enter the ASCII value in the box and check the box to enable the option, or uncheck it to disable.
- Press the "Send" button to make the SSE232-LE take the new configuration parameters.

COM A

Baud Rate	9600
Parity	EVEN
Data Bits	8
Com Type	RS232

Mode	CLIENT
Local Port (1..65535)	1000
Server's IP Address	192.168.0.100
Server's Port(1..65535)	1000

Time Window (0..2000 ms)	0
End Character (0..255)	50 <input checked="" type="checkbox"/>
Inactivity Time Out (0..10000 min)	0

<input type="button" value="Send"/>	

You can also configure these parameters through the configuration command console. When executing the commands that allow you to change these parameters, you must indicate the COM you are referring to.

Table 7 - Configuration of serial ports

Command	Description
BAUDx: (Baud_rate)	Configures the rate of serial transference of the COM x in bps. Baud_rate it may be 300, 600, 1200, 2400, 4800, 9600, 14400, 19200, 28800, 33600, 38400 o 115200.
PARITYx: (N E O)	Configures the parity of the COM x N = NONE E = EVEN O = ODD
BITSx: (7 8)	Configures the amount of bits of data of the COM x.
COMTYPEx: (0..3)	Configures the Type of serial Port for the COM x. 0 = RS-232 without flow control 1 = RS-232 with flow control 2 = RS-485 (only SSE232-1C43-LE) 3 = RS-422 (only SSE232-1C43-LE)
WINDOWx: (0..2000)	Configures the window of time for the COM x. The rate of values is expressed in milliseconds.
ENDCHARx: (0..255)	Configures the end character for the COM x. The value corresponds to the ASCII value of the end character.

3.2.4 Inactivity timeout and Automatic Reset

Inactivity Timeout: Both in Client Mode and in Server Mode, the maximum time allowed for inactivity may be configured. Once this period of time lapses, SSE232-LE will consider the connection terminated and will close it down. This option can be disabled so the connection will not be closed even if no flow of information is detected. It is configured through the **Inactivity Timeout** parameter independently for each channel. If this value is 0, the connection will not be shut down due to the inactivity of that channel, i.e. the option is disabled.

Automatic Reset: In Server Mode, it may be the case that the connection of a client shuts down if this client or another one tries to connect the server channel of the SSE232-LE that has the automatic reset option enabled. SSE232-LE will abort the previous connection, allowing the new client to connect. If the automatic reset is not enabled for that server channel, SSE232-LE will not allow the connection of the new client and, in this case, the server may use the option of inactivity timeout.

If the server channel has the automatic reset option enabled, and there is a connection established with a client and another one tries to connect to the same server, the connection with the previous client will be closed and the connection to the server of the new client will be allowed.

Summing up:

- **Enabled Automatic Reset:** If a new client tries to connect to an already opened link (with or without the same client) the previous connection will be aborted to allow the connection of the new client.
- **Disabled Automatic Reset:** It will prevent a new client to connect if there already exists an open link on the Server Port.

You may configure the Automatic Reset Option through the SSE232-LE Web Page:

- Select "Network" from the menu, you will see the Network configuration page.
- Select the Automatic Reset Enabling from the combo box.
- Click on the "Send" button, so the SSE232-LE may take the changes.

The screenshot shows a web configuration interface with the following settings:

- Web Configuration: ENABLED
- Automatic Reset: ENABLED
- Connection Protocol: DISABLED (highlighted by a mouse cursor)
- Digital Input Report: ENABLED

A "Send" button is located at the bottom left of the configuration area.

You may configure the Automatic Reset option through the command console by executing the **ARESET** command.

Table 8 - ARESET command

Command	Description
ARESET: (E D)	Configures the Automatic Reset option for the channels in server mode E = Enables D = Disables

3.2.5 Server Mode Channel Configuration

The SSE232-LE channel configured in Server Mode will be on hold, waiting for a connection in a specified port (configurable by the user).

If the connection is closed, the device will stay on hold, waiting for a new connection in that Port.

In Server Mode, the parameters for the channel must be configured as follows:

- **Mode:** The mode for the channel must be Server Mode.
- **Port:** This identifies the TCP Port to which the clients that wish to send information must connect. The information sent goes through the corresponding serial COM and vice-versa.
- **Inactivity Timeout:** Time of inactivity of the link after which SSE232-LE will consider the connection to the server terminated if no flow of information is detected.

To configure these parameters through the SSE232-LE Web Page:

- Select the "COM A" link from the menu.
- Enter the values as necessary.
- Click on the "Send" button, so the SSE232-LE may take the changes.

The screenshot shows a web-based configuration interface for the SSE232-LE device. It is divided into two sections by a horizontal line. The top section contains:

- Mode:** A dropdown menu set to "SERVER".
- Local Port (1..65535):** A text input field containing "1000".
- Server's IP Address:** A text input field containing "192.168.0.100".
- Server's Port(1..65535):** A text input field containing "1000".

 The bottom section contains:

- Time Window (0..2000 ms):** A text input field containing "0".
- End Character (0..255):** A text input field containing "50" with a checked checkbox to its right.
- Inactivity Time Out (0..10000 min):** A text input field containing "10".

 At the bottom left of the form is a "Send" button with a mouse cursor pointing to it.

You may use the configuration command console to change these parameters. In the commands that allow to change these parameters you must indicate the COM you are referring to.

Table 9 - Server Mode Channel Configuration

Command	Description
MODE _x : (S C)	Configures the COM x mode. To select Server Mode, select S.
PORT _x : (1..65535)	Port in which the client's connection is waited.
INACTOUT _x : (0..10000)	Maximum time of inactivity allowed to the connection corresponding to the COM x, after which the connection is terminated and the device returns to client waiting mode. It is expressed in minutes.

3.2.6 Client Mode Channel Configuration

In Client Mode, each channel tries to connect to a specified server (IP-Port) every 10 seconds. Once the connection established, the information of the socket is transparently transmitted by the corresponding COM and vice versa.

These are the configuration parameters for that channel in client mode:

- **Mode:** The channel mode must be configured as Client.
- **Port:** Client channel Port.
- **Server IP:** IP address of the server to which the client's channel will connect.
- **Server Port:** Server Port of the server to which the client's channel will connect.

- **Inactivity Timeout:** Time of inactivity of the link, after which SSE232-LE will consider the connection to the server terminated if no flow of information is detected.

To configure these parameters through the SSE232-LE Web Page:

- Select the "COM A" link from the menu.
- Enter the values as necessary.
- Click on the "Send" button, so the SSE232-LE may take the changes.

The screenshot shows a web-based configuration interface for the SSE232-LE device. The 'Mode' is set to 'CLIENT'. The 'Local Port' is 1000, 'Server's IP Address' is 192.168.0.100, and 'Server's Port' is 1000. The 'Time Window' is 0 ms, 'End Character' is 50 (with a checked checkbox), and 'Inactivity Time Out' is 10 min. A 'Send' button is visible at the bottom left.

You may use the configuration command console to change these parameters. In the commands that allow to change these parameters you must indicate the COM you are referring to.

Table 10 - Client Mode Channel Configuration

Command	Description
MODE _x : (S C)	Configures the COM x mode. To select Client Mode, select C.
PORT _x : (1..65535)	Client Port for the COM x.
IPSERV _x : (aaa.bbb.ccc.ddd)	Server IP address to which the COM x will connect.
PORTSERV _x : (1..65535)	Server Port to which the COM x will connect
INACTOUT _x : (0..10000)	Maximum time of inactivity allowed to the connection corresponding to the COM x, after which the connection is terminated and the device re-attempts to connect to the server. It is expressed in minutes.

3.2.7 Multidrop Mode

There exists the possibility to accept up to 8 clients simultaneously. SSE232-1XXX-LE maintains 8 server type connections on the same channel and transmits information to the serial port RS-232/485/422 (RS-485 and RS-422 available in model SSE232-1CXX-LE) that has been received by every TCP communication link. The information received by the serial port is transmitted to all the clients of the Ethernet network.

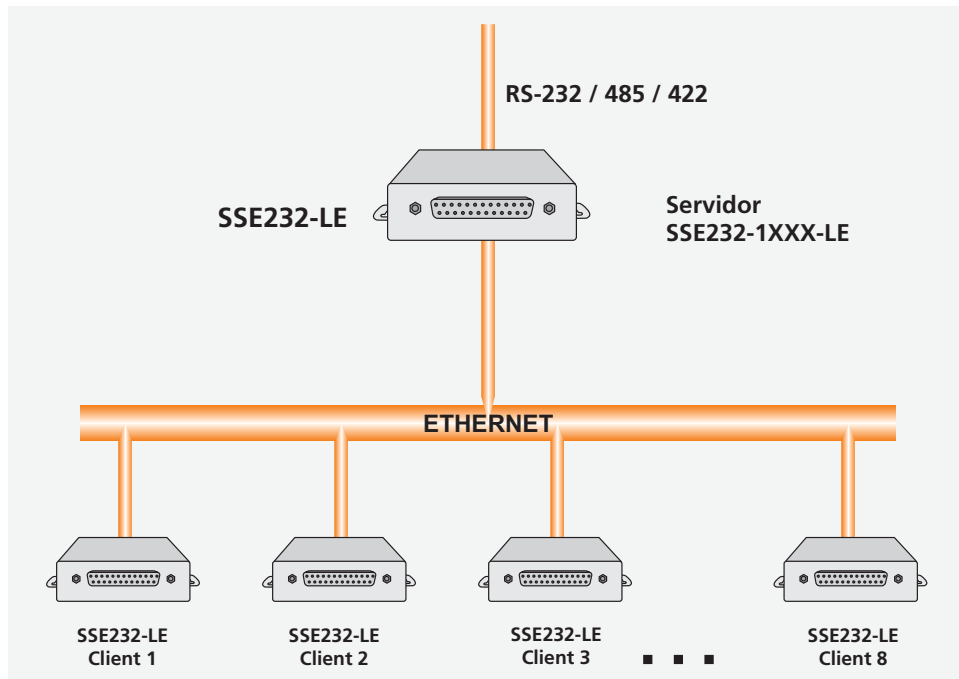

Figure 7 - Multidrop Mode: up to 8 clients

3.2.8 Supervision and Control Port.

SSE232-LE incorporates the possibility to administer digital inputs/outputs and to supervise the status of the connection sockets linked to every channel by simple commands. The Supervision and Control Port works through a TCP connection in the port 999. Each command must end with the CR character (ASCII 13). The system will answer if each command has been successfully executed or not.

3.2.8.1 Supervision of Connections Commands

You may supervise the connections by executing the **STA** and **RST** commands. The **STA** command will allow you to know the status of the connection of a channel on the Ethernet side by answering '1' (Connected) or '0' (Disconnected). The **RST** command allows to reset the socket of a specified channel. If your command is related to a socket of a channel that is not available on that model, the answer will be "error".

Table 11 - STA and RST commands

Command	Description	Answer
STA<CR>	Shows the connection status of the sockets of all the channels available (according to the model)	STA,wxyz<CR> w, x, y, z: they may be '1' o '0' 1 = Connected 0 = Disconnected
RST:x<CR>	Resets the socket of channel x. The channel can be: A = COM A B = COM B C = COM C D = COM D Depends on the amount of available channels in the SSE232-LE model	RST:x,OK<CR> Channel x has been successfully reset RST:x,ERROR<CR> The channel x has not been successfully reset or the channel is not available in this model.

3.3 UDP Transport Protocol

You may select the transport protocol for the Ethernet interface. Possible protocols are: **TCP** and **UDP**.

The selection of the transport protocol affects all SSE232-LE channels. Thus, if you select the TCP protocol, all the channels will use this protocol. And the same applies to the UDP protocol.

To change the protocol through the SSE232-LE configuration Web Page:

- Select "Network" from the menu, you will see the Network configuration page.
- Select the Transport Protocol from the combo box.
- Click on the "Send" button, so the SSE232-LE may take the changes.

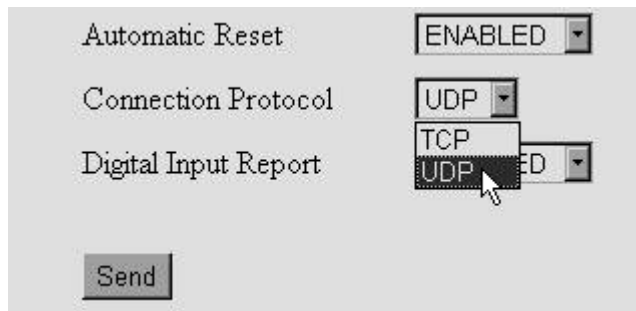

You may also change the protocol by executing the **PROTOCOL** command through the command console.

Table 12 - PROTOCOL command

Command	Description
PROTOCOL:(T U)	Configures the network protocol for all SSE232-LE channels. T = TCP U = UDP

3.3.1 Client Channel with UDP Protocol

For a channel in Client Mode, you must configure the IP address and Port of the server to which it will connect. If you use an UDP Transport Protocol, that channel will transmit to that IP-Port the information received by the serial and vice versa.

If the IP server address of that channel coincides with the broadcast address (IPSERV = 255.255.255.255), SSE232-LE will transmit to an UDP broadcast all the information received by the serial. The serial will transmit whatever is received from the Ethernet side, no matter if the information was received from a broadcast or from a specified IP address.

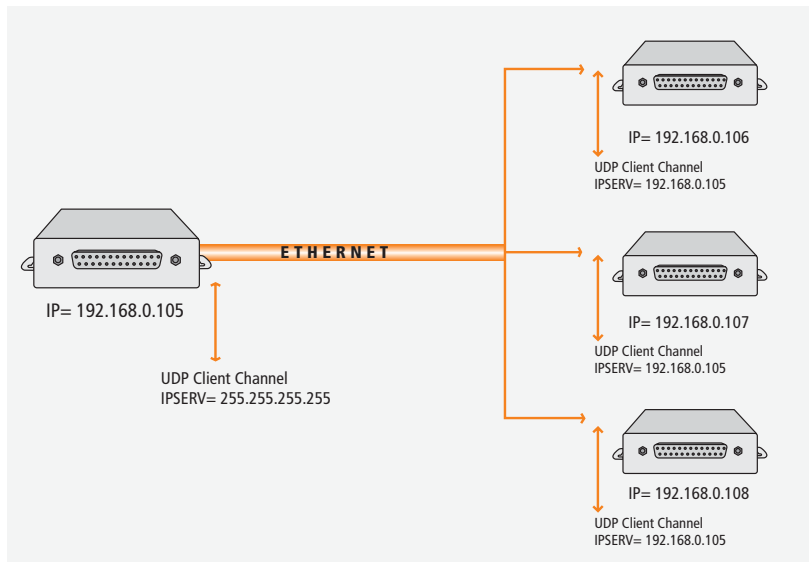

Figure 8 - An SSE232-LE Client Broadcasts to all clients with IPSERV = Fixed IP

3.3.2 Server Channel with UDP Protocol

For a channel in Server Mode, you must only configure that channel's Port. When the transport protocol is UDP, the server channel will be "linked" to the first IP address plus Port that sends a packet.

The **Inactivity Timeout** parameter must also be configured, and it will work similarly as in TCP mode. It will terminate the link with a specified IP address (the first to have sent a packet) once the predetermined time lapses, thus allowing another IP address to establish communication with the UDP server channel.

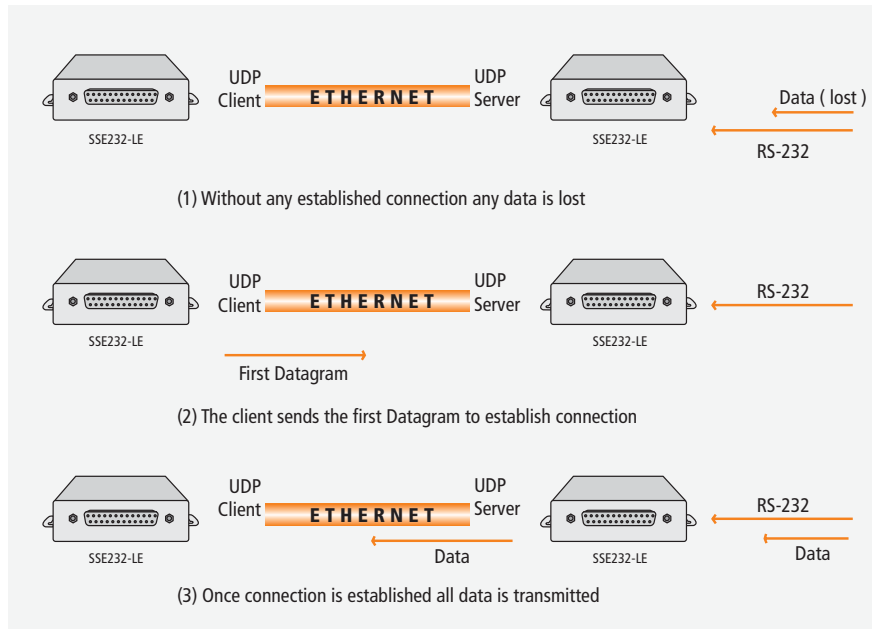

Figure 9 - Two SSE232-LE UDP, one client and one server

When two SSE232-LE connect through an UDP Transport Protocol, one of them in Client Mode and the other in Server Mode, the SSE232-LE in Server mode will not send the information received by the serial to the Client's IP unless the client has previously sent a packet to establish communication. In other words, the SSE232-LE Server will have to receive a UDP packet from the client to be linked to that IP. After that, all the information received by the serial port will be transmitted to the client's IP.

If the client fails to send a packet to the server, the server will not be able to establish a link and the information received by the corresponding serial will be lost.

3.3.3 Connection Between Two UDP Clients.

The UDP mode, as different from TCP mode, allows communication between two devices configured on Client Mode. This mode shows an advantage over client-server topology, since connection can be established in both ways, without regard of which of the serial devices sends the information first.

In this case, both devices must be configured in Client Mode and the IPSERV and PORTSERV of the other device must be also configured.

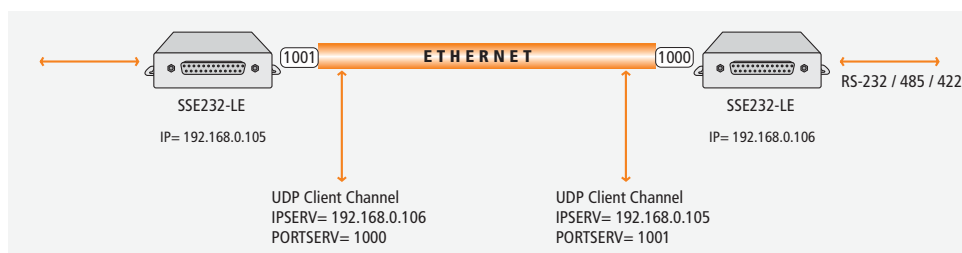

Figure 10 - Connection between two UDP clients

Appendix A

A.Appendix

A.1. Device Locator Application

The Exemys Device Locator Application Program is intended to use for the basic configuration of any Exemys device over your ethernet network. It allows to search, identify and configure the basic network parameters.

This simple application program is distributed with any Exemys product in the accompanying CD. You can also download the latest version of this program from the Exemys Web Site (www.exemys.com).

The Device Locator application must be running from any PC within the network where the Exemys devices to configure are installed.

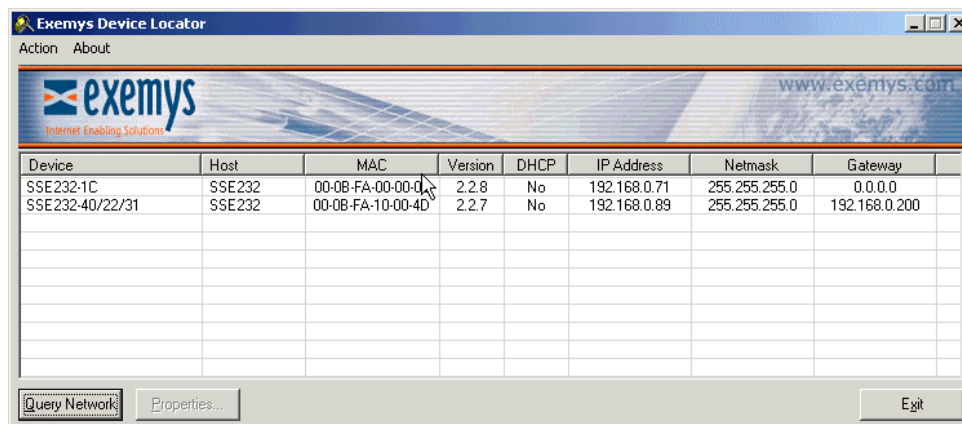

Figure 11 - Exemys Device Locator

When the Device Locator is run for the first time it will search any Exemys device within the network. If there is an Exemys device in the network it will be shown in Device Locator Grid:

- Device: Device name, such as SSE232-LE or KIBe.
- Version: Firmware version it is running in that device.
- MAC Address: Hardware Ethernet Address of the device.
- IP: IP Address configured in the device
- Netmask: Subnet mask configured in the device
- Gateway: Gateway IP Address configured in the device.

- DHCP Lease: if "Yes", then the device network parameters were obtained from a DHCP server.

It is not necessary for the device to be properly configured. If the device is correctly connected and working, it will be found by the Device Locator Application Program.

To refresh the grid, click on the "Query Network" button. This action will make the device Locator search any Exemys device in the network again.

You can change any of these basic network parameters within the Device Locator program.

To configure any Exemys device found by the Device Locator:

- Select the device in the grid and click on the "Properties" button, or open the "Actions" menu and select the "Properties" command. You will see the Properties dialog box.
 - All Exemys devices provide a Remote Configuration Password. This password is used for the Web configuration page and remote command Console in the device. Enter this password in the "Enter current password" box if the device has a configured password.
 - You can type an IP Address, Netmask and Gateway IP Address or you can click on the "Use DHCP" check box to make the device search a DHCP Server.
 - Click on the "Ok" button so the Device Locator sends this information to the device.
- If the password is not correct, the Device Locator will show a "**Error Response from MAC Address 00-0B-FA-XX-XX-XX**". The device will not respond any message sent by the Device Locator software within the first 5 seconds after an incorrect password configuration attempt. This is to avoid any brute force method to change the network parameters of the device.
 - If the device does not respond, the Device Locator will show a "**No Response from Device**" message. Make sure the device is turned on and connected to the ethernet network.
 - The Exemys device will reset so the changes in the configuration take effect.
 - Click on the "Close" button to close the Properties dialog box.
 - After a few seconds the device being reset will answer again to the requests of the Device Locator software. Click on the "Query network" button to refresh the grid and make sure the parameters were changed.

A.2. Indicator Leds Codes

SSE232-LE features two indicator LEDs: green and yellow.
The Yellow and it shows the general working order of the equipment.
The green led indicates data incoming status.

Figure 12 - Indicator Leds Codes

Yellow Led	Green Led	Description
It flashes alternately with Green Led	It flashes alternately with the Yellow Led	Critical failure.
It is steady on		SSE232-LE is searching for a DHCP server on the network.
It is ½ second on and ½ second off.		SSE232-LE is waiting for an IP address configuration ping or the CFG command to be entered.
It blinks like a beacon, 90% of a second off and the remaining 10% on.		SSE232-LE has an IP address and a carrier (link) on the connection. This is the normal operation status.
It is 90% of a second on and the remaining 10% off		It has no IP address and it could not find a DHCP server. It will search the DHCP server at 60-second intervals.
It blinks very fast.		Absence of carrier on the link.
	It is steady on and it turns off for shorts periods of time	SSE232-LE has detected Data in one of the connections

A.3. Default Configuration

This is the factory default configuration.

Table 13 - Default Configuration

Parameter	Value
IP	0.0.0.0 (DHCP)
Netmask	0.0.0.0
Gateway	0.0.0.0
Protocol	TCP
Automatic Reset	Enabled
Web Configuration	Enabled
Digital Input Report	Disabled
Remote Configuration Password	None
Baud Rate	9600
Parity	None
Data Bits	8 bits
End char	Disabled
Window of time	Disabled (0ms)
Mode	Server
Listen Port (Server Mode)	1000
Server IP Address (Client Mode)	192.168.0.99
IP Port Server Number (Client Mode)	1000
Inactivity Timeout	Disabled
COM Type	Depends on the SSE232-LE model

A.4. Connectors Pinout

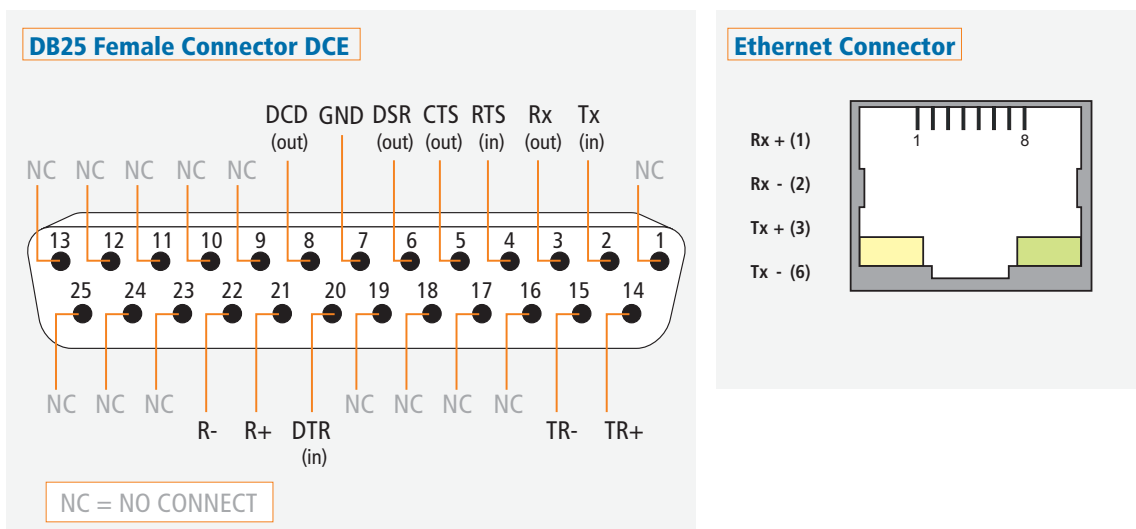

Figure 13 - Connectors Pinout

A.5. Technical Specifications

• Network protocols:	TCP/IP, UDP, TELNET, HTTP, DHCP, ICMP, ARP.
• Network port:	Ethernet 10-Base T, RJ45 plug
• Serial protocol:	Transparent.
• Serial port:	RS-232, RS-485, RS-422, all tied to a DB25 female (DCE) Connector.
• Supported devices:	Any device with a serial RS232/485/422 port requiring an access to an Ethernet network.
• Flow control:	RTS/CTS.
• Connection control:	DSR/DTR/DCD.
• Administration:	Embedded HTTP server, password protected. Telnet-like console, password protected. Serial console, password protected.
• Firmware:	Upgradable, by using a programming cable (not included).
• Leds:	Status led, data led/link.
• Size/Weight:	1 x 2.75 x 3.15 inches (HxWxL) 0.772 Lbs.
• Power Supply:	9-26 VAC, 9-30 VAC 200mA max
• Temperature:	Operating temperature: 23 to 149 °F (-5 to 65°C). Storage temperature: -40 to 167 °F (-40 to 70 °C).
• Accessories not included:	Programming cable. COM port redirector software. DIN rail mounting plug-in.
• Warranty/support:	Limited one year warranty. Technical Support included.